

Operating manual TROX air terminal units Type VFC volume flow controllers

VFC

VFC series volume flow controllers



General information	2
Correct use	2
Safety notes	2
Area of application	2
Operating modes	2
Product description	3
Installation	4
Commissioning and wiring	5
Constant volume flow rate operation	5
Variable volume flow rate operation, actuator with potentiometers	6
\dot{V}_{\min} - \dot{V}_{\max} switching wiring	7
Variable volume flow rate wiring	7
\dot{V}_{\min} - \dot{V}_{\max} switching operation, actuator with mechanical stops	8
\dot{V}_{\min} - \dot{V}_{\max} switching wiring	9
\dot{V}_{\min} - \dot{V}_{\max} switching setting	10
Retrofitting an actuator	11
Variable volume flow rate expansion set	11
\dot{V}_{\min} - \dot{V}_{\max} switching expansion set	12

VFC series volume flow controllers				Expansion set	
Code ¹⁾	Function	Actuator TROX part no.		Code	TROX part no.
		until 4/2018	from 5/2018		
-	Constant volume flow rate	-	-	-	-
E01	24 V, \dot{V}_{\min} - \dot{V}_{\max} switching, potentiometer	M466EP6	A00000038358	E01	NR-VAV-E01
E02	230 VAC, \dot{V}_{\min} - \dot{V}_{\max} switching, potentiometer	M466EP8	A00000038359	E02	NR-VAV-E02
E03	24 V AC/DC, variable volume flow, potentiometer, control signal 0 to 10 V DC	M466EP7	A00000038360	E03	NR-VAV-E03
M01	24 V, \dot{V}_{\min} - \dot{V}_{\max} switching, mechanical stops	M466EP4	M466EP4	M01	NR-VAV-M01
M02	230 VAC, \dot{V}_{\min} - \dot{V}_{\max} switching, mechanical stops	M466EP5	M466EP4	M02	NR-VAV-M02

1) Actuators for CAV controllers according to order code

Operating manual

TROX air terminal units

Type VFC volume flow controllers

VFC

General information

Correct use

The volume flow controllers are suitable for use in ventilation and air conditioning systems. Particular conditions can restrict the functioning capacity and must be taken into account during the design stage:

- Use of VFC series volume flow controller in aircraft is not permitted.
- In systems with aggressive air, only air terminal units made of plastic should be used, subject to extensive tests for suitability.
- Galvanised sheet steel units must not be installed in contaminated environments (e.g. acetic acid).
- The controller and actuator do not contain any parts that can be exchanged or repaired by the user.
- The actuator contains electronic components therefore must be separated from domestic waste. When disposed of, local up to date regulations must be complied with.
- The mechanical components of VFC series volume flow controllers are maintenance-free.
- Sticky constituents of the air, in particular in association with fluff, can lead to impairment or failure of the regulation function.

Incorrect use

- Do not use the controller with polluted air (e.g. dust, fluff) or contaminated air (as in laboratories).
- Do not use the controller outdoors, in wet areas, or in areas with potentially explosive atmospheres.

Safety notes



Danger!

Danger of electric shock! Do not touch any live components! Electrical equipment carries a dangerous electrical voltage.

- Only skilled qualified electricians are allowed to work on the electrical system.
- Switch off the power supply before working on any electrical equipment.

- Safety transformers must be used.
- Installation should only be carried out by specialists. The normal rules of site working, in particular the health and safety regulations must be complied with.
- For installation, wiring, and commissioning observe the recognised technical regulations, especially safety and accident prevention regulations.
- Due to the danger of injury on edges and burrs, transport and installation may only be performed while wearing gloves.

- Install the units proficiently with suspension points and secure with locknuts. Only load the suspension points with the units' own weight. Adjacent components and connecting ducts must be supported separately.
- Only use units with ATEX approval for rooms containing a potentially explosive atmosphere.

Area of application

TROX VFC series volume flow controllers are mechanical system-powered controllers for controlling the airflow in constant and variable air volume systems.

3 variants of the volume flow controllers are available:

- Constant volume flow rate
- \dot{V}_{\min} - \dot{V}_{\max} switching
Actuator with potentiometers (type E01, E02)
Actuator with mechanical stops (type M01, M02)
- Variable volume flow rate,
Actuator with potentiometers (type E03)

The set flow rate must always be set by the customer on site. The setting is made without adjustment devices. Each volume flow controller has a sticker with a characteristic for determining the volume flow rate. One or two settings are read off and transferred to the rotary knob or actuator (potentiometer or mechanical stops).

Operating modes

- Constant volume flow rate
The volume flow controller keeps the set flow rate constant independently of the duct pressure.
- Variable volume flow rate
The volume flow controller keeps a variable set flow rate constant independently of the duct pressure. For this purpose, the volume flow controller receives a control variable from a room temperature controller or air quality controller, a set point adjuster or a DDC outstation. The control variable is a 0 to 10 V DC voltage signal.
- \dot{V}_{\min} - \dot{V}_{\max} switching
The volume flow controller works with two setpoint values that are switched over using switches or relays provided by the customer.

Operating manual TROX air terminal units Type VFC volume flow controllers

VFC

Product description

Constant volume flow rate

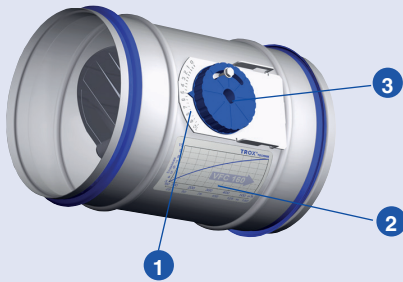

- For constant air flow rate
- Volume flow rate is set on site using the rotary knob
- Factory setting 5

Variable volume flow rate, actuator with potentiometers

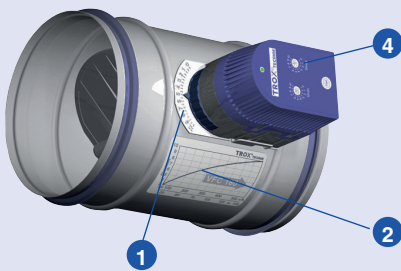

E01 ... E03

Actuator E01, E02, E03

- For variable airflow rate or \dot{V}_{\min} - \dot{V}_{\max} switching
- Volume flow rate is set on potentiometers
- Shut-off down to leakage airflow is possible (setting 0)
- Height of the actuator 85 mm
- Factory settings:
 $\dot{V}_{\min} = 4$
 $\dot{V}_{\max} = 8$

\dot{V}_{\min} - \dot{V}_{\max} switching, actuator with mechanical stops

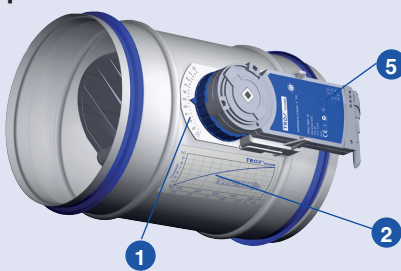

M01 ... M02

Actuator M01, M02

- For \dot{V}_{\min} - \dot{V}_{\max} switching
- Volume flow rate is set using mechanical stops
- Shut-off down to leakage airflow is possible (setting 0)
- Flat design, height of the actuator 35 mm

- 1 Adjustment scale
- 2 Volume flow rate characteristic
- 3 Rotary knob
- 4 Actuator, volume flow rate is set on potentiometers
- 5 Actuator, volume flow rate is set with mechanical stops

For technical and acoustic data on VFC series volume flow controllers, refer to the control units catalogue.

Operating manual TROX air terminal units Type VFC volume flow controllers

VFC

Installation

Installation behind a bend

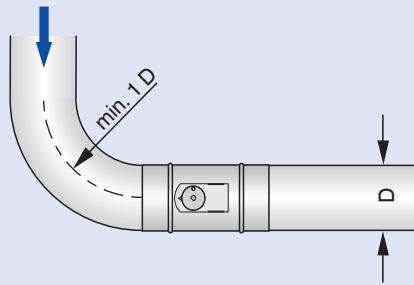

Combination with volume flow rate measuring unit

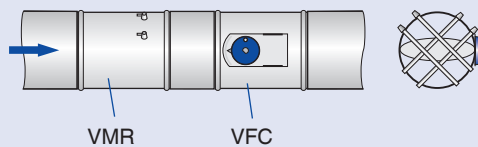

Installation in a branch

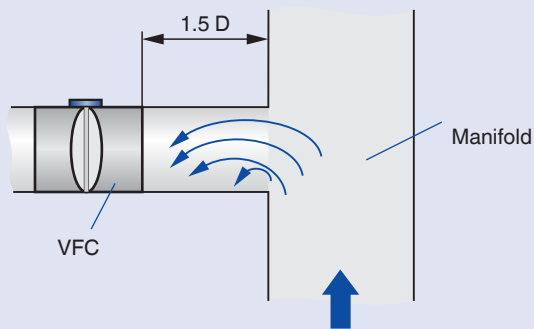

Connection with ducting

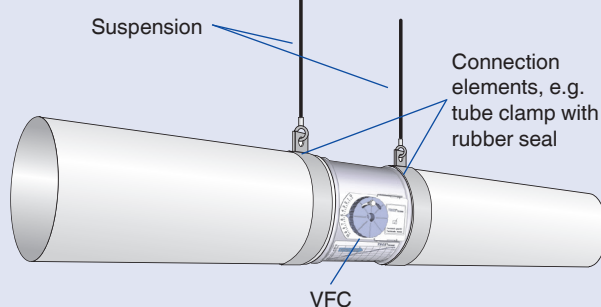

Installation location and type of connection

- Select the installation location so the scale and characteristic of the controller remain accessible.
- With reference to the characteristic, set the pointer to the required volume flow rate.
- Horizontal or vertical controller installation.
- Note the airflow direction according to the arrow on the characteristic.
- Note for installation in front of and behind elbows, flaps or other obstacles with aerodynamic and acoustic effects.
- Horizontal or vertical installation; in combination with volume flow rate measuring unit (VMR), arrange the sensor tubes at 45° offset from the controller axis.
- Installation behind a bend:
Maintain a curvature radius of at least 1D unless there is an additional straight inflow length.
- Direct connection to a main duct/manifold: Maintain at least 1.5 D straight inflow length
- Shorter inflow lengths result in tighter tolerances.
- Direct connection to a main duct is permitted without perforated sheet metal in extract air operation.
- Free intake not permitted, inflow length 1.5 D required. Inflow nozzles are recommended in order to reduce the pressure losses.

Connection with ducting

The connection diameters are appropriate for tubes according to EN 1506 or EN 13180.

- No drilling work is allowed to be performed on the controller!
- Before connecting the controllers, check the ducting for contamination.
- Use standard TROX lip seals for connecting to the ducting.

Operating manual TROX air terminal units Type VFC volume flow controllers

VFC

Commissioning and wiring

Constant volume flow rate operation



Setting the set flow rate

Each VFC carries a characteristic to determine the setting values on site (see example, nominal size 160).

\dot{V}_{\min} settings below 3 result in an unregulated airflow dependent on the duct pressure that is not less than $\dot{V}_{\min-\text{unit}}$.

Characteristic for determining the volume flow rate

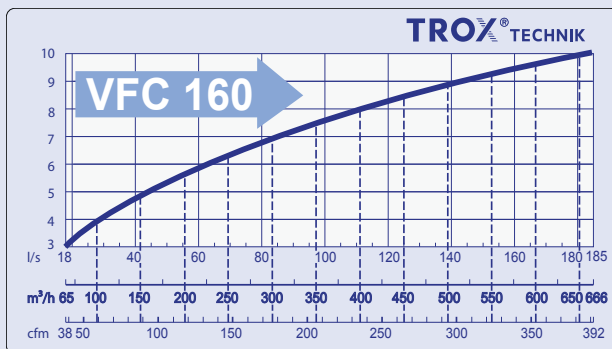

Constant volume flow control, volume flow rate setting with rotary knob

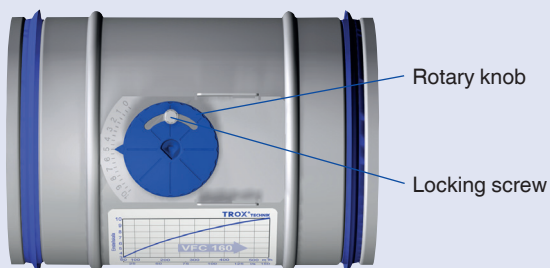

Set the set flow rate as follows:

- Determine the setting value for the set flow rate from the characteristic or the table below.
- Unscrew the locking screw.
- Move the pointer of the rotary knob to the setting value.
- Tighten the locking screw.

Volume flow rate setting values

Nominal size	l/s								m³/h							
	Value to be set								Value to be set							
	3	4	5	6	7	8	9	10	3	4	5	6	7	8	9	10
80	6	7	10	14	19	25	33	42	20	26	35	49	68	91	119	150
100	6	10	15	22	30	40	50	65	22	36	54	79	108	144	180	234
125	11	15	22	30	44	60	78	100	40	54	79	108	160	215	280	360
160	18	31	45	60	83	110	146	183	65	110	162	216	300	396	525	660
200	25	40	60	85	120	155	205	250	90	144	216	306	432	558	738	900
250	37	64	100	135	183	240	310	370	133	230	360	486	660	864	1116	1332

Operating manual TROX air terminal units Type VFC volume flow controllers

Actuator E01 ... E03

Variable volume flow rate operation, actuator with potentiometers

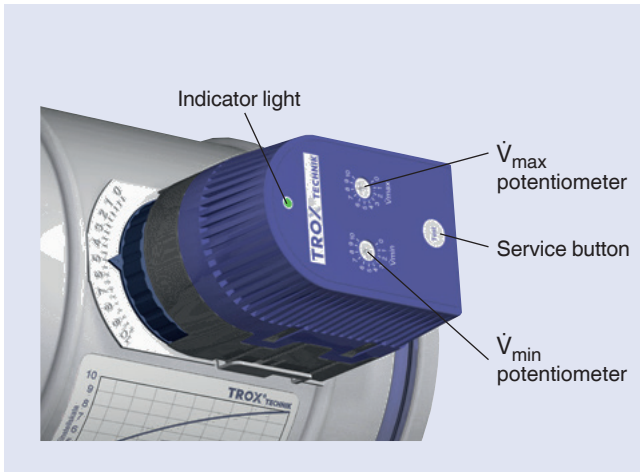

Setting the set flow rate

Each VFC carries a characteristic to determine the setting values on site (see example, nominal size 160).

\dot{V}_{\min} values below 3 results in an unregulated airflow dependent on the duct pressure that is not less than $\dot{V}_{\min\text{-unit}}$.

Set the set flow rate as follows:

- Determine the setting value for the set flow rate from the characteristic or the table on page 5.
- Set the values on the \dot{V}_{\min} - and \dot{V}_{\max} potentiometers.
- Factory setting:
 - $\dot{V}_{\min} = 4$
 - $\dot{V}_{\max} = 8$
- Shut-off down to leakage airflow is possible, value to be set 0

Functional test

A functional test can be performed very easily using the service button and the indicator light.

- Press service button for at least 1 second
- Actuator turns toward \dot{V}_{\min}
- Actuator turns toward \dot{V}_{\max}
- Actuator returns to control mode

Indicator light provides functional information

- Permanently on : Position set
- Flashing once a second : Actuator operating
- Flashing twice a second : Actuator is jammed and stationary
- Off : No supply voltage

Characteristic for determining the volume flow rate

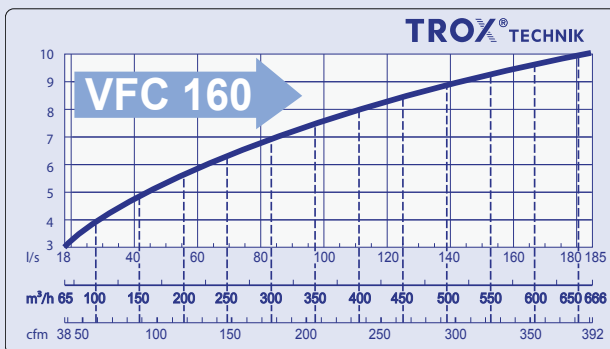

Characteristics of the control signal

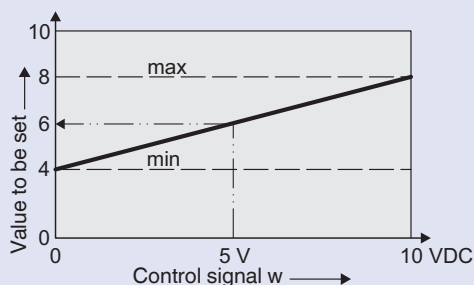

E03

Characteristic of the actual value signal

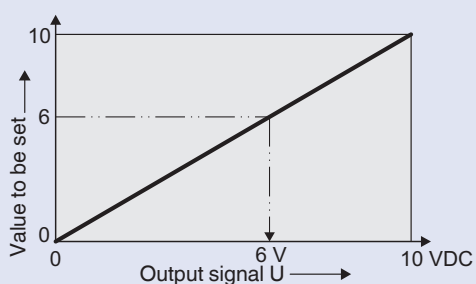

E03

Actuator E03

The relationships between the setting value and output signal U, or control signal w, are shown in the two characteristics on the left.

The output signal does not correspond to the currently measured volume flow rate, but reflects the setpoint value.

Example:

Factory set values:

$$\dot{V}_{\min} = 4$$

$$\dot{V}_{\max} = 8$$

Required value: 6

--> Required control signal: 5 V

Available output signal: 6 V corresponding to set value 6

Operating manual TROX air terminal units Type VFC volume flow controllers

Actuator E01 ... E03

\dot{V}_{\min} - \dot{V}_{\max} switching wiring

1-wire control \dot{V}_{\min} / \dot{V}_{\max}

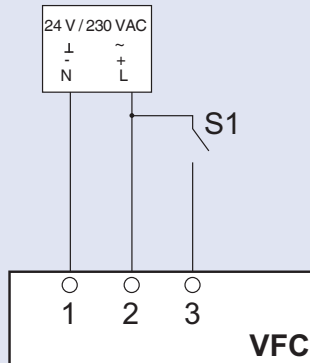

E01, E02

2-wire control \dot{V}_{\min} / \dot{V}_{\max}

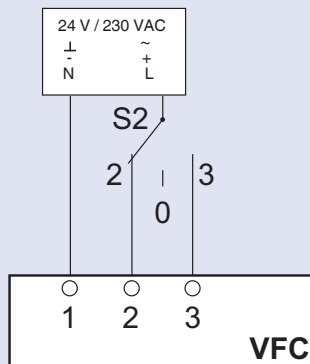

E01, E02

Variable volume flow rate wiring

Continuous control input signal

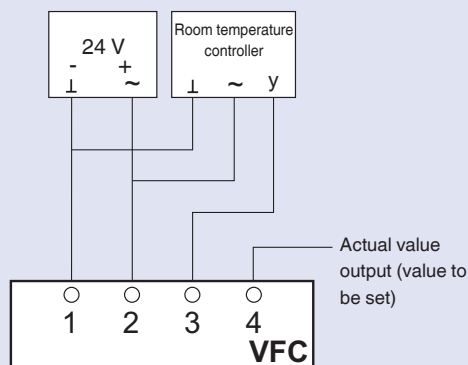

E03



Danger!

Danger of electric shock! Do not touch any live components! Electrical equipment carries a dangerous electrical voltage.

- Only skilled qualified electricians are allowed to work on the electrical system.
- Switch off the power supply before working on any electrical equipment.

Actuator E01, E02

Electrical connection data:

E01:	24 V AC $\pm 20\%$	50/60 Hz;	4 VA
	24 V DC $\pm 20\%$		2,5 W
E02:	230 V AC	50/60 Hz	4 VA

Switches provided by the customer (volt-free contacts) can be used for making the switching procedures shown below:

1-wire control (illustration above)

Switch S1 open : \dot{V}_{\min}

Switch S1 closed : \dot{V}_{\max}

2-wire control (3-point) (illustration in middle)

Switch S2 at 0: Drive stopped

Switch S2 at 2: \dot{V}_{\min}

Switch S2 at 3: \dot{V}_{\max}

Actuator E03

Electrical connection data:

Supply:	24 V AC $\pm 20\%$	50/60 Hz	4 VA
	24 V DC $\pm 20\%$		2,5 W
Control signal:	0-10 V DC		Ra > 100 kohm
Actual value output:	0-10 V DC		

Room temperature control

A dedicated room temperature controller or a DDC outstation with 0-10 V DC output is connected with at least 2 wires (terminals 1 and 3) as shown in the circuit diagram. If the controllers are on the same supply voltage (24 V) make sure that terminal 1 of the VFC is identical to the ground of the control signal.

Note:

Override control \dot{V}_{\max} with 24 V DC at terminal 3.

Operating manual TROX air terminal units Type VFC volume flow controllers

Actuator M01 ... M02

\dot{V}_{\min} - \dot{V}_{\max} switching operation, actuator with mechanical stops



Setting the set flow rate

Each VFC carries a characteristic to determine the setting values on site (see example, nominal size 160).

\dot{V}_{\min} settings below 3 results in an unregulated airflow dependent on the duct pressure that is not less than $\dot{V}_{\min\text{-unit}}$.

Characteristic for determining the volume flow rate

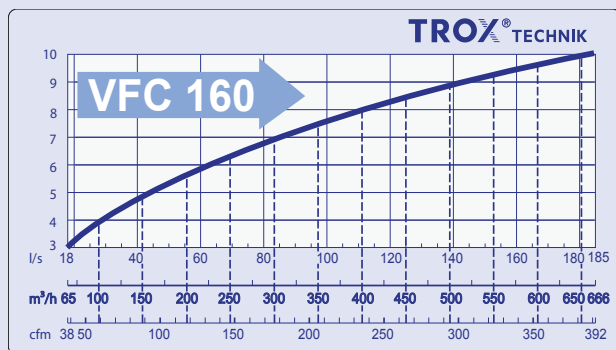

Set the set flow rate as follows:

- Determine the setting value for the set flow rate from the characteristic or the table on page 5.
- Activate gearbox disengagement with magnet. The magnet is integrated in the removable position indicator
- Make the corresponding settings on the mechanical stops.
- Deactivate gearbox disengagement again and reconnect the position indicator, see also page 10.

Variable volume flow control, \dot{V}_{\min} and \dot{V}_{\max} setting with mechanical stops



Magnetic gearbox disengagement Ⓜ

Mechanical stop for \dot{V}_{\min}

Position indicator with magnet

Mechanical stop for \dot{V}_{\max}

Operating manual TROX air terminal units Type VFC volume flow controllers

Actuator M01 ... M02

\dot{V}_{\min} - \dot{V}_{\max} switching wiring

1-wire control \dot{V}_{\min} / \dot{V}_{\max}

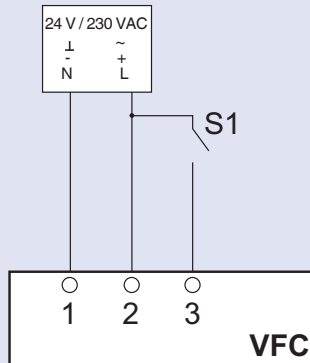

M01, M02

2-wire control (3-point) \dot{V}_{\min} / \dot{V}_{\max}

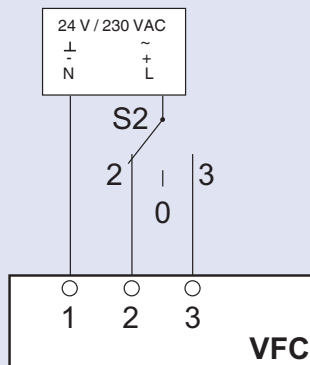

M01, M02



Danger!

Danger of electric shock! Do not touch any live components! Electrical equipment carries a dangerous electrical voltage.

- Only skilled qualified electricians are allowed to work on the electrical system.
- Switch off the power supply before working on any electrical equipment.

Electrical connection data:

M01:	24 V AC $\pm 20\%$	50/60 Hz	1 VA
	24 V DC $\pm 20\%$		0,5 W
M02:	230 V AC	50/60 Hz	3 VA

Switches provided by the customer (volt-free contacts) can be used for making the switching procedures shown below:

1-wire control (illustration above)

Switch S1 open : \dot{V}_{\max}

Switch S1 closed : \dot{V}_{\min}

2-wire control (3-point) (illustration in middle)

Switch S2 at 0: Drive stopped

Switch S2 at 2: \dot{V}_{\max}

Switch S2 at 3: \dot{V}_{\min}

Operating manual TROX air terminal units Type VFC volume flow controllers

Actuator M01 ... M02

\dot{V}_{\min} - \dot{V}_{\max} switching setting

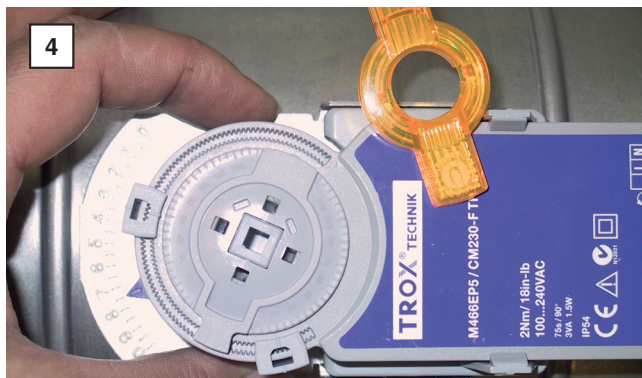
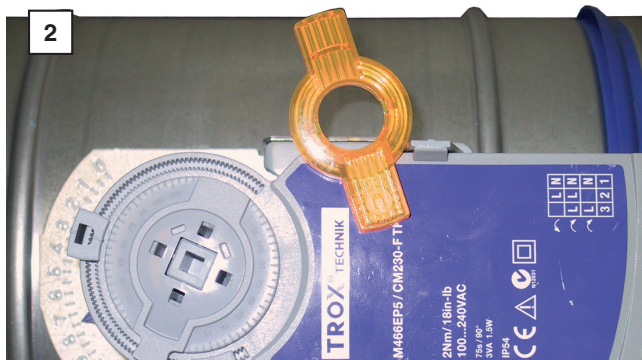
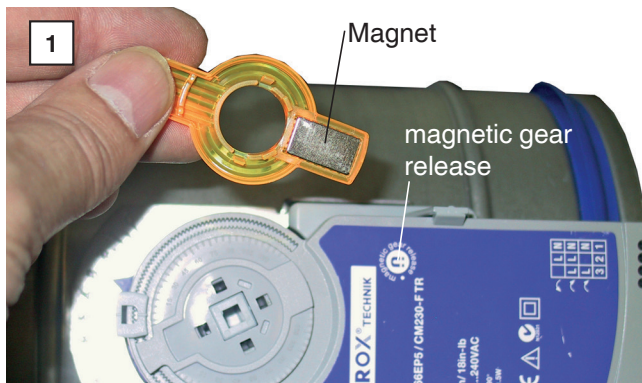

Setting the mechanical stops

Remove the position indicator, there is a magnet on the reverse

Place the magnet on the point indicated with "magnetic gear release". The gearbox is now disengaged and the actuator can be moved. Ⓢ

Remove the mechanical limiters

Set \dot{V}_{\min} or \dot{V}_{\max} on the rotary knob; reattach the mechanical limiters in the corresponding positions.

Remove the position indicator with magnet and put back on the axial holder.

Operating manual TROX air terminal units Type VFC volume flow controllers

Actuator E01 ... E03

Retrofitting an actuator

Variable volume flow rate expansion set

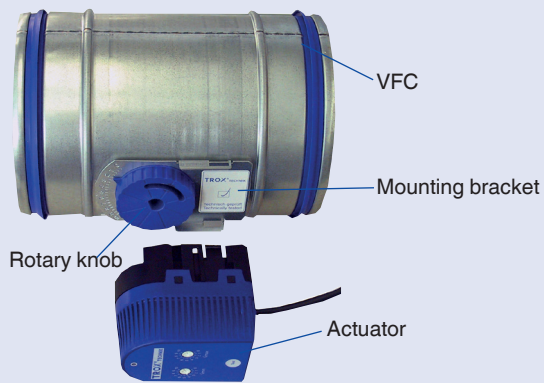

Subsequent installation of actuators

The VFC version with a rotary knob can be subsequently equipped with an actuator.

For this purpose, it is first necessary to remove the locking screw and move the rotary knob to position 5. The actuator is simply pushed on, and it engages in the mounting bracket.

Order code for expansion sets, see page 1

Mounting the actuator

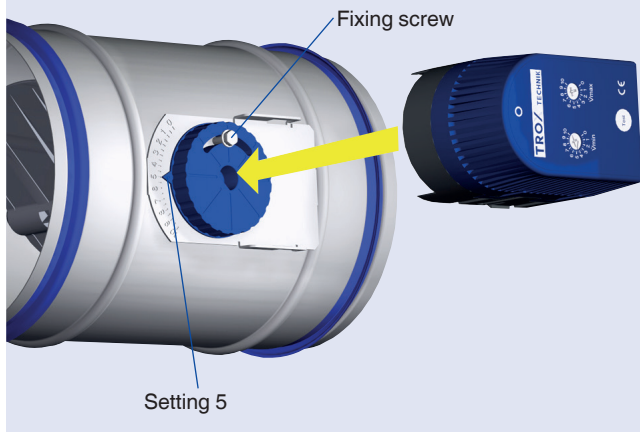

Perform the following steps to mount the actuator:

- Unscrew the locking screw and remove it
- Move the rotary knob to setting 5
- Push on the actuator until the fixing lugs engage
- See page 6 for setting the set flow rates

Operating manual TROX air terminal units Type VFC volume flow controllers

Actuator M01 ... M02

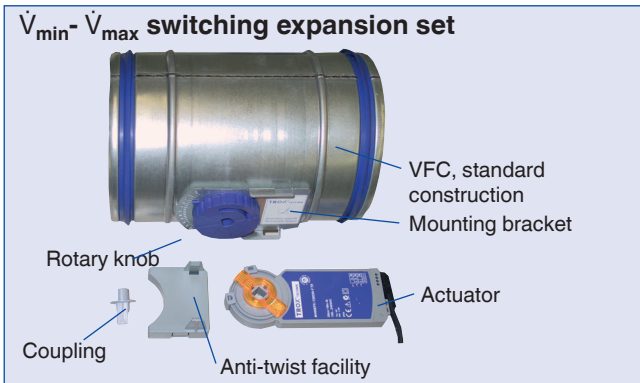

Subsequent installation of actuators

The VFC version with a rotary knob can be subsequently equipped with an actuator. For this purpose, it is first necessary to remove the locking screw and move the rotary knob to position 5.

Order code for expansion sets, see page 1

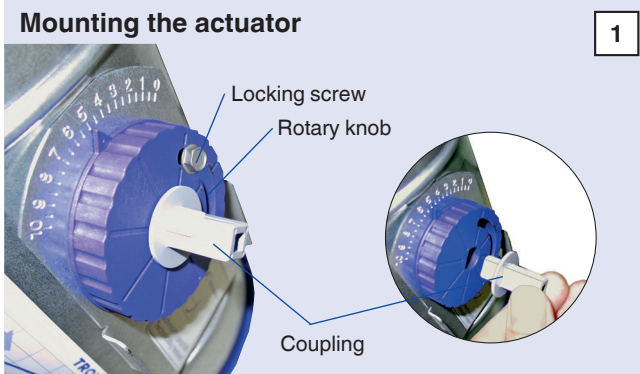

Perform the following steps to mount the actuator:

- Unscrew the locking screw and remove it
- Move the rotary knob to position 5
- Engage the coupling

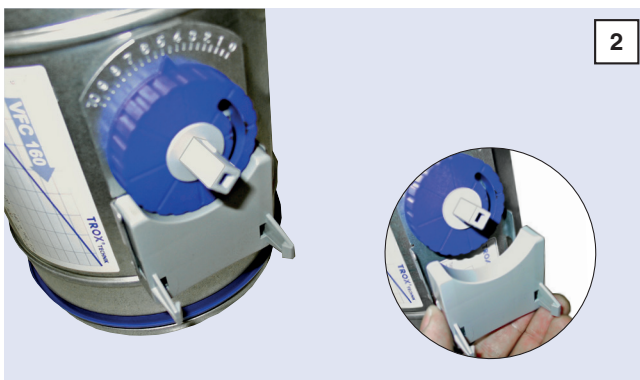

- Engage the anti-twist facility on the mounting bracket

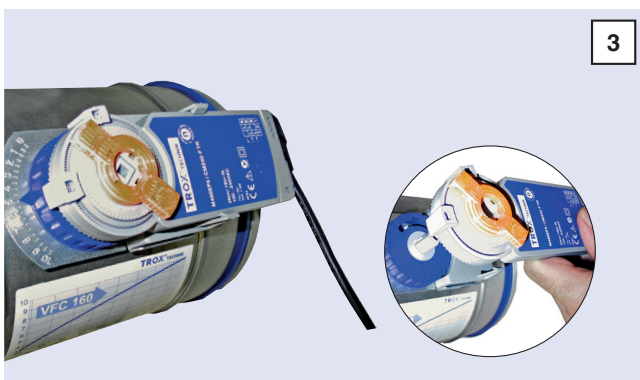

- Attach the actuator, it engages in the anti-twist facility
- See page 10 for setting the set flow rates